

# USER MANUAL

Smart Safe OX

## What's Included

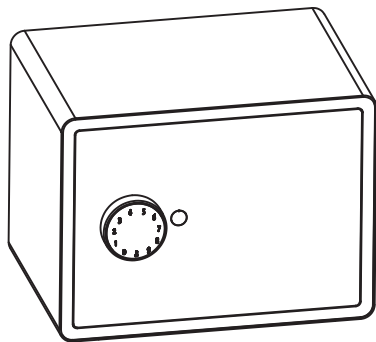

Smart Safe OX x 1

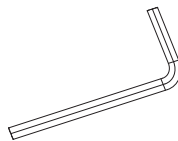

M6 Screw Driver x 1

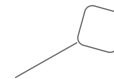

Reset Tool x 1

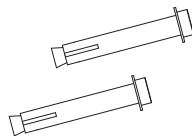

M6 Wall-Mount Screw x 2



Embedding Screw x 2

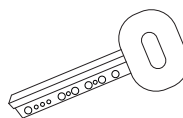

Mechanical Key x 1

## Specification

<b>Model</b>	OX
<b>Material</b>	Galvanized steel
<b>Battery</b>	4×AA Battery
<b>Unlock Mechanism</b>	Bluetooth, PIN Code, App, Mechanical Key

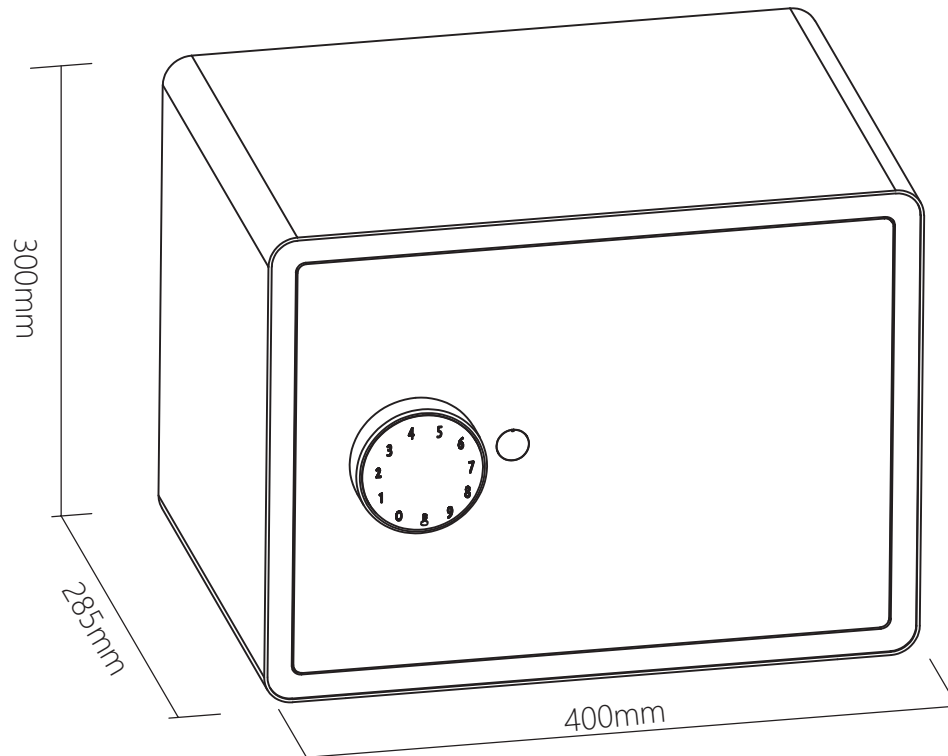

# Features

## Lock&Unlock



### **Administrator Unlock**

Set a Master Administrator PIN for Unlocking, settings, operations etc. And only the administrator could change the administrator PIN code.



### **User Unlock**

This Smart Safe allows to add up to 200 user PIN codes for your family and friends.

## Mobile Control



### **Bluetooth one-touch unlock**

With your Mobile you could unlock the Safe by tapping the "🔒" on the App.



### **Mobile Administrator**

Set Administrator PIN Codes from your Mobile to unlock, add users, delete users, etc.



### **Remote Sharing**

You could generate offline code through mobile App and let your friends and family access the Safe.

## Battery



### **Battery Life**

The battery lifetime will be 12 months for operating.



### **Low Consumption**

BLE broadcasting turns to sleep mode if no operations.



### **Low Battery**

When the battery runs out of power, system will remind you to replace the batteries.

## Burglar Alarm



The alarm will be activated if anyone move the Safe, and the High decibel buzzer will be turned on and keep beeping.

## Emergency



### **Emergency Unlocked**

When the power is down, we can use Mechanical Key to open the Safe.



### **System Lockdown**

The lock will be lockdown for 5 minutes if continuously enter wrong PINs for 5 times.

## Installation

>. Please use the 2 wall mounting screws to fix the safe on your wall or cabinet.

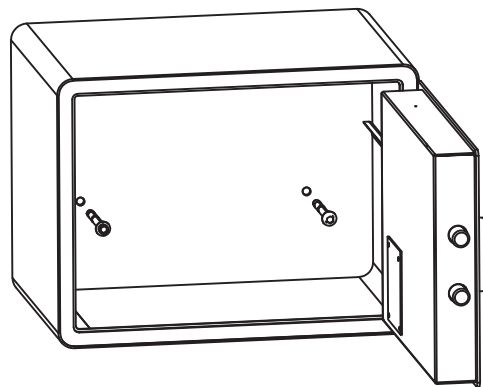
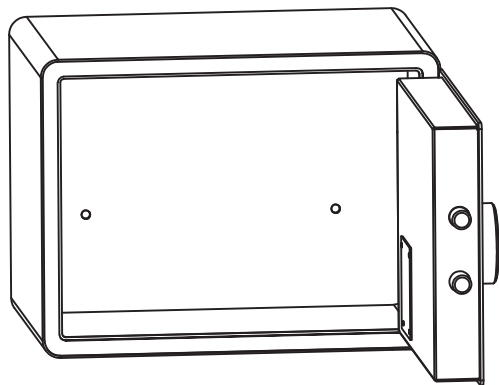

## Quick Start

### Step 1 > Install Battery

>. Put 4 × AA Battery into the battery dock.

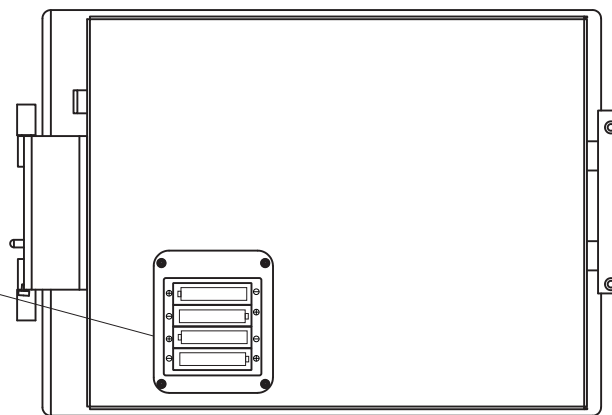
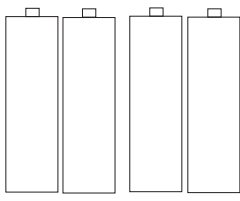

## Step 2>Download Mobile App

>1. Scan QR Code below and download the App and turn on your mobile Bluetooth



## Step 3>Add Device

>1. Go to App Home page, click "Add Device" or click "+" on the upper right.

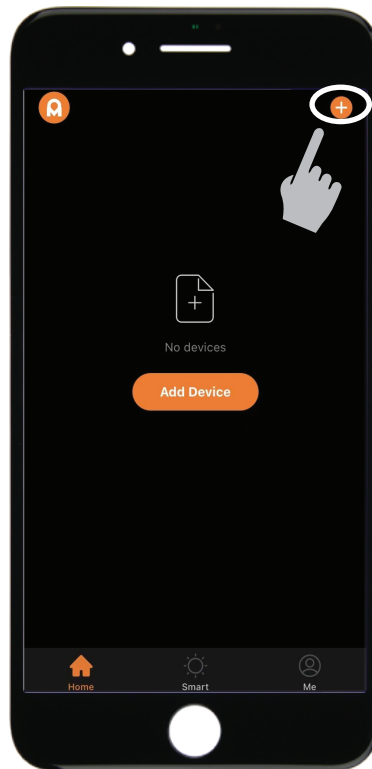

> 2. Tap **🔑** + 9 + **🔑** + admin code + **🔑** , when you see the light slowly blinks in blue then you are ready to pair

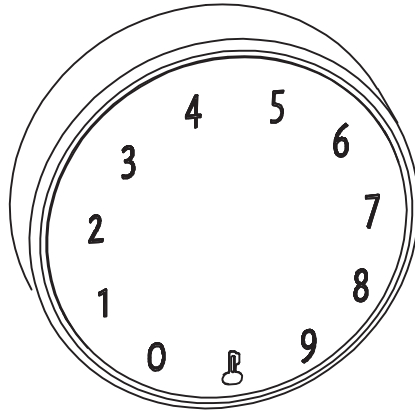

>3. You will see the detected device and click "Go to add".

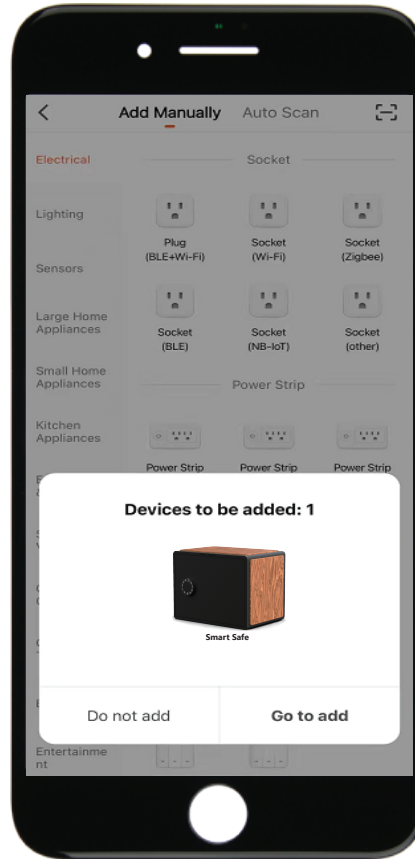



>4. Connecting, you need to wait for a few seconds to let it finish.

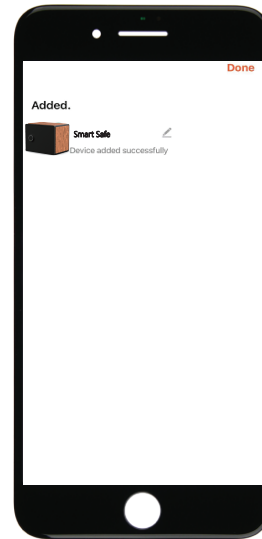
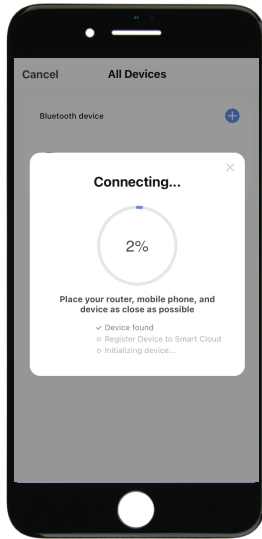

>5. Device added

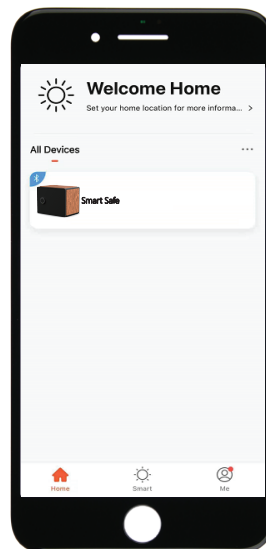

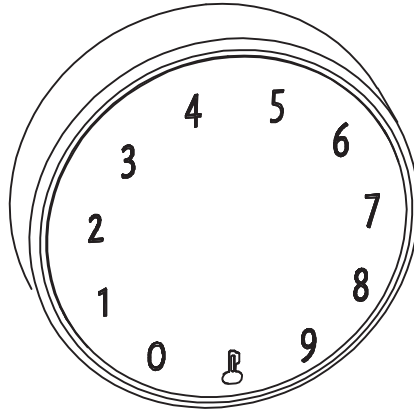

## Step 4>Change Admin Password-Initial Admin Password:123456

>1. Tap  and hold for 3 seconds and release, you will be hearing 2 quick beeps.



>2. Right after the 2 beeps please key in:

Initial admin code+  + new admin code+  +new admin code again+  , when you hear a long beep with green light the admin code has been changed.

# Mechanical Instructions

## Password & Factory Mode:

### 1. Password Length

Password must be 6 digits (no more or less)

### 2. Add User Password

- Tap **⏏** + 0 + **⏏** until the blue light blinks
  - >. Enter admin password + **⏏**
  - >. Enter new user password + **⏏**
  - >. Enter new user password again and press **⏏**
  - >. When the **⏏** (Enter button) blinks in green, user password has been set.

### 3. Delete Password

- Tap **⏏** + 2 + **⏏** until the blue light blinks
  - >. Enter admin password and press **⏏**
  - >. Enter the user password you wish to delete and press **⏏**
  - >. Enter the user password again and press **⏏**
  - >. When the **⏏** (Enter button) blinks in green the password has been deleted.

### 4. Delete All Passwords

- Tap **⏏** + 00000 + **⏏** until the blue light blinks
  - >. Enter admin password and press **⏏**
  - >. When the **⏏** (Enter button) blinks in green, all user passwords have been deleted.

### 5. System Lock-down

The Smart Safe will Lock-down for 5 minutes if entering wrong password continuously 5 times.

### 6. Virtual digits-Anti Peeping

Add any digits before and after the correct password the Safe unlock as always.

### 7. Reset Factory Mode

Use the reset tool press and hold the reset button for 5 seconds until a long beep.

## Bluetooth broadcasting & re-connecting:

Bluetooth will turn to sleep mode and lights out if no operations within 1 minute.

Tap any key to activate the Bluetooth, App&Device will get reconnected each other.

# App Instructions

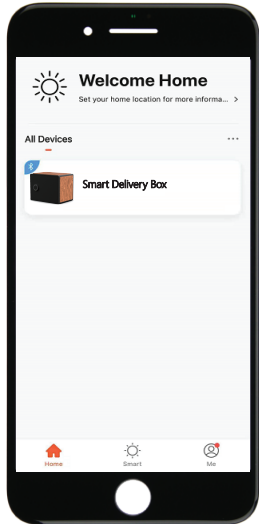

- ☑ You will see all devices and rooms on the home page.
- ☑ Tap the Device to start operating.
- ☑ Tap "Me" at the bottom to manage your home.

- ☑ Touch the lock sign to unlock and lock.
- ☑ Tap  to check the alarm records.
- ☑ Tap "Members" to add or delete members.
- ☑ Tap "Opening Logs" to check opening logs.
- ☑ Tap "Intelligent Linkage" to turn on and off go home mode.
- ☑ Tap "Setting" to manage passwords.

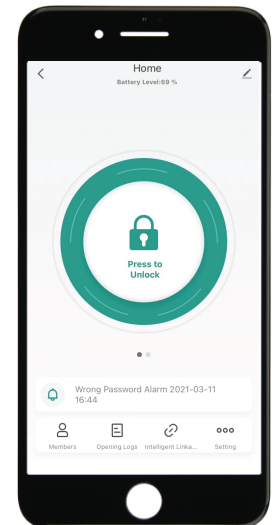

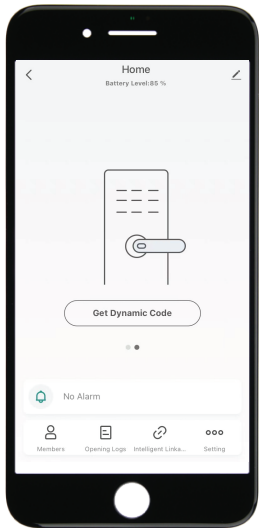

- ☒ Tap "Get dynamic code" to get a code.
- ☒ Tap "Copy Code" and send it to friend or family.
- ☒ Tap  to edit your personal information.

- ☒ Tap "+" to add family member or others.
- ☒ Tap added members to edit member's information.

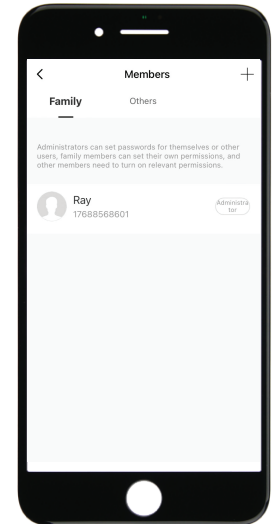

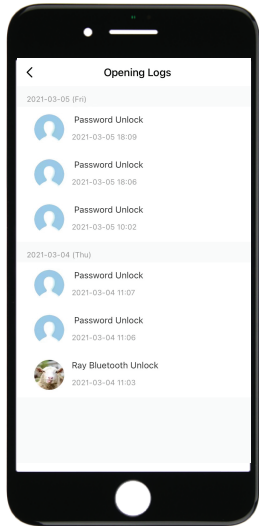

☑ You will find out when and whom opened the Safe.

☑ Tap the green bar and save to turn on the function.

☑ Tap the orange bar and save to turn on the function.

☑ You will get notification if user unlocked with Bluetooth

☑ Go to "Me" homepage and go to message center to check the records.

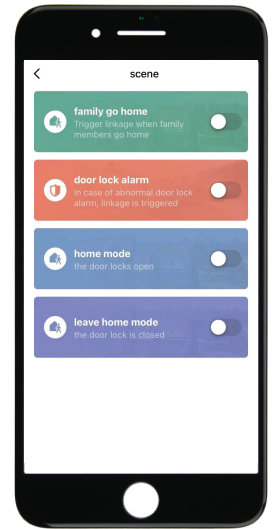

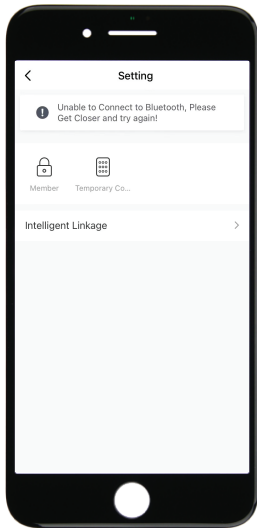

☒ Tap “Member” to manage members’ information.

☒ Tap “Temporary Code” to manage on-line and off-line codes.

☒ Tap “One-Time Password” under Online Password to set an on-line one-time code.

☒ Tap “Add Online Periodic Code” under Online Code to set an on-line code which will be available in a period of time.

☒ Tap “One-Time Password” under Off-line Password to generate an one-time off-line code which will be a 10 digits code and use it when the device is off-line.

☒ Tap “Add Off-line Periodic Code” under Off-line Code to generate an off-line code (10 digits) which will be available for a period of time, and use it when the device is off-line or Bluetooth disconnected with device.

☒ Tap “Clear Code” to generate a code (10 digits) which will be able to clear single or all the off-line codes.

☒ Please note if the code less than 10 digits you need to regenerate a new code, the code must be 10 digits.

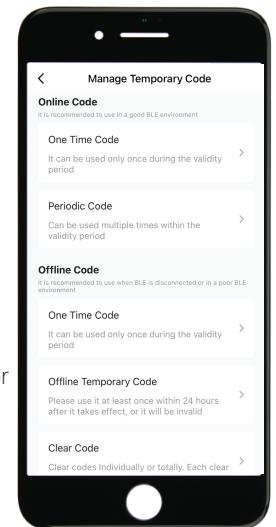

**OMUARK**  
WWW.OMUARK.COM